

# MERC TRAINING TABLE



**PALERMO LS-4-8A**

With roll-and-lock casters, the flip top training table Palermo is easy to move, store, or lock in place. You can link multiple tables together to create the perfect training space.



✓ Flipped and nested design for easy mobility and convenient storage



## BENEFITS



### **Mobility and storage**

very easily flipped and nested



### **Single-handed operation**

simple flip-top mechanism provides complete ease of use



**VIAspace**

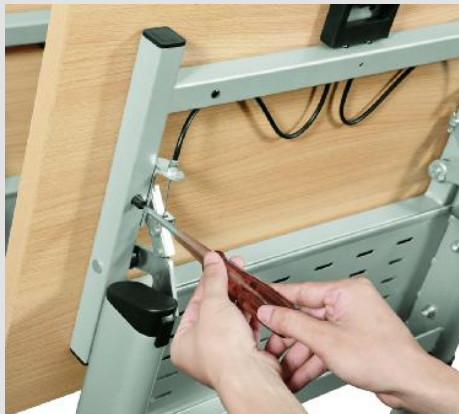

### **Table top height difference adjustment**

by screwing in and out the black screw in case table top is not horizontally constrained



### **Large 3 inch castors**

Easily roll through thick carpets

## MATERIAL

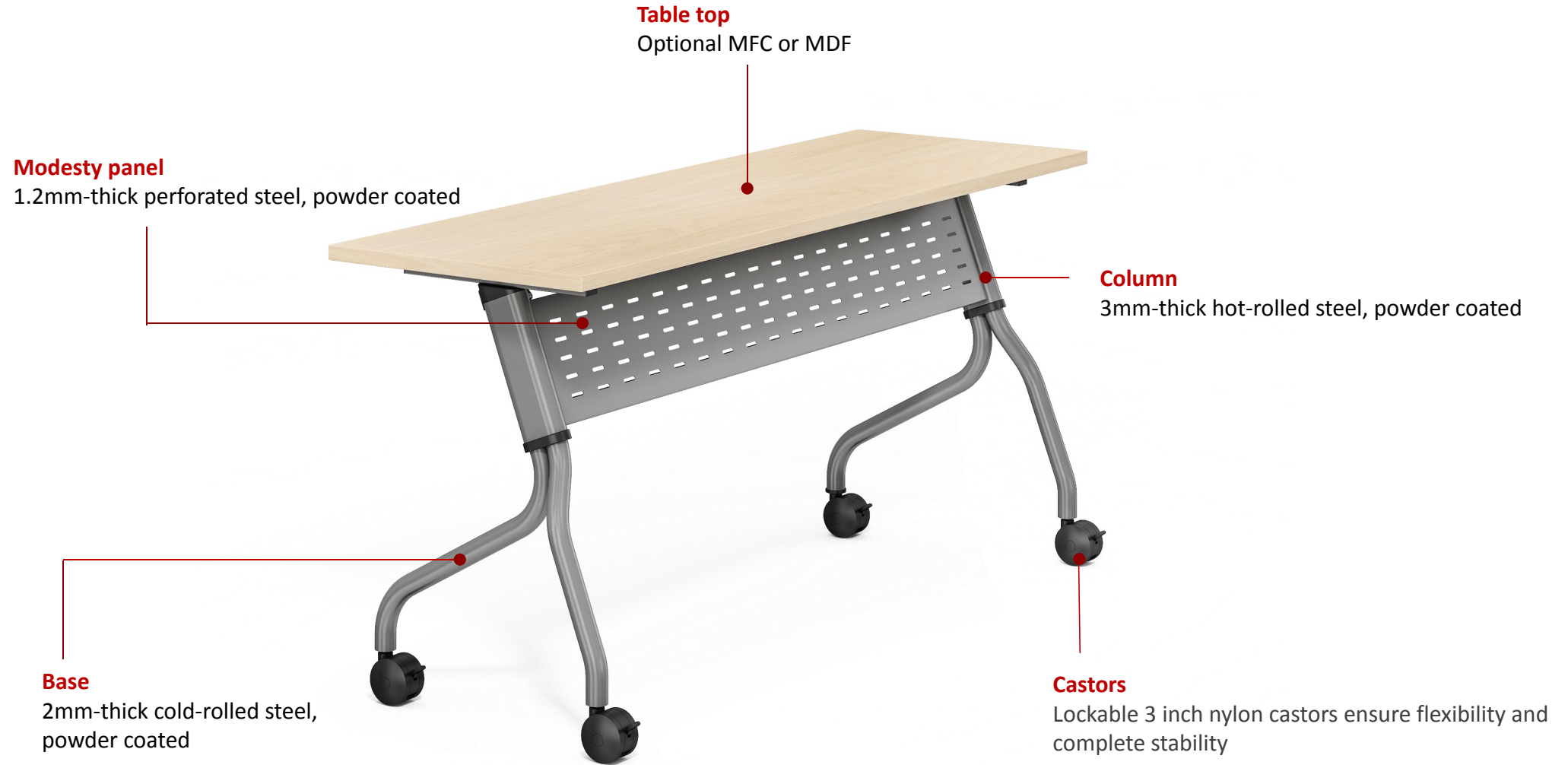

# OPTIONS



**Ganging kit** Easy to clamp wood tops

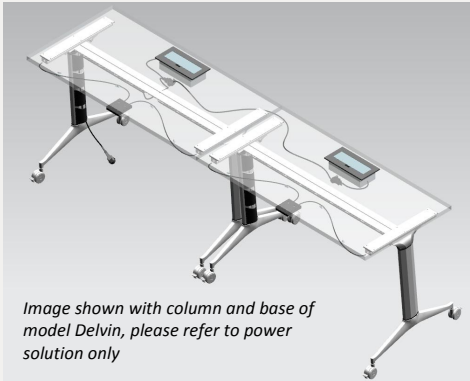

*Image shown with column and base of model Delvin, please refer to power solution only*



**Power solution**

Power block includes power and data cabling



**Table Top Corner Edge** Optional square, round or knift corner edging

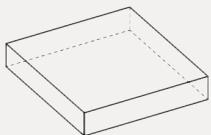

Square

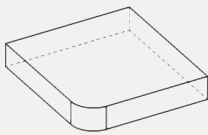

Round

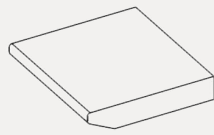

Knift





### Powder Coat Color

Color options for bracket, column and base

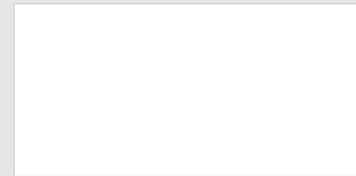

White – standard color  
(refer to PANTONE 11-0601 TPG)



Silver with shiny surface  
(refer to PANTONE 17-4402 TPG)



Black  
(refer to PANTONE 19-4305 TPG)



### Wood Finishings

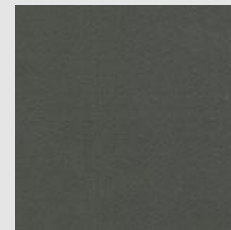

Navy blue Gray



North American

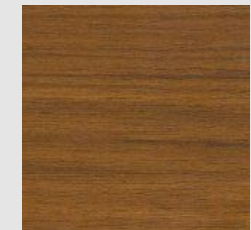

South Asian Teak

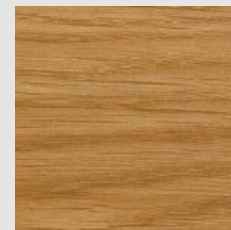

Norwe Oak

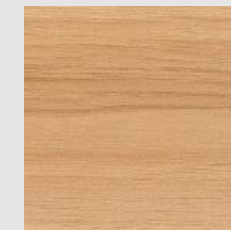

White Walnut

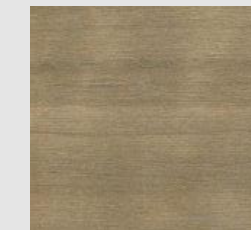

Rinaja Walnut



White Oak

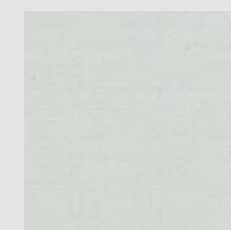

Gray White

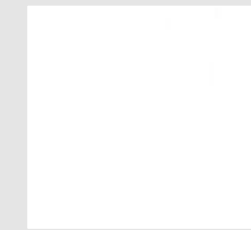

White

# POPULAR CONFIGURATIONS

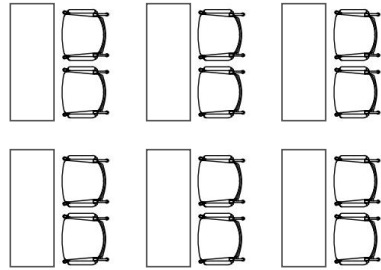

Training

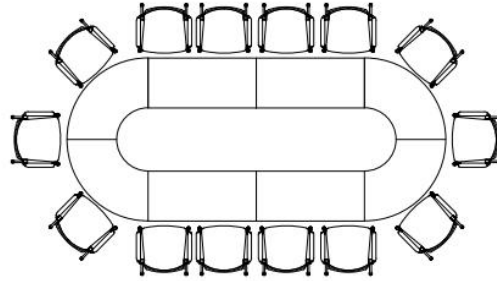

Oval

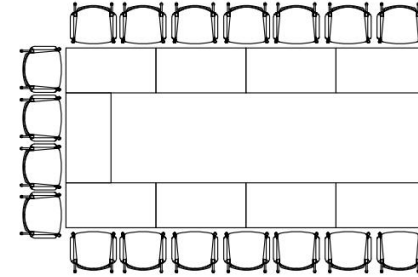

U shape

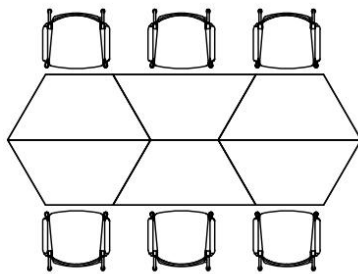

Elongated Hexagon

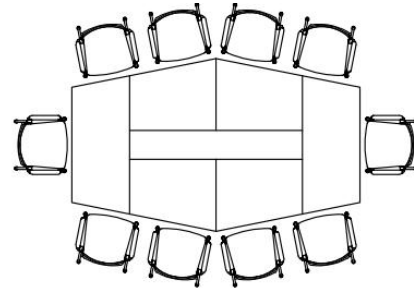

Elongated Hexagon

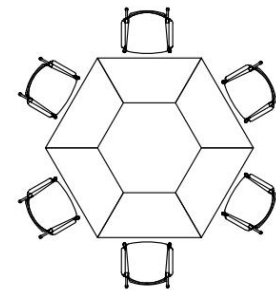

Regular hexagon

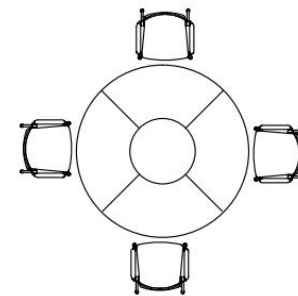





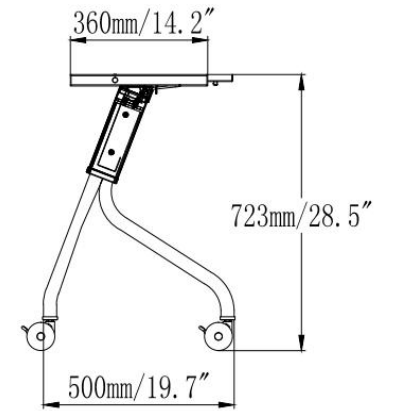
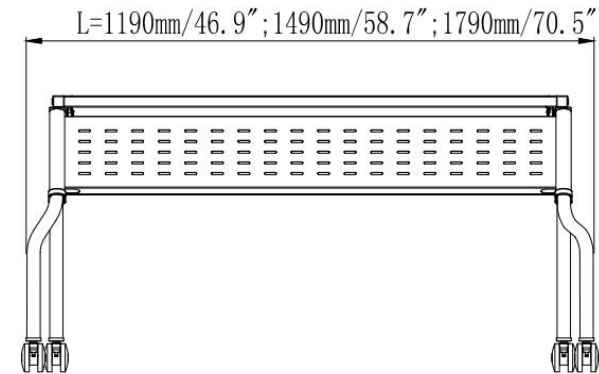
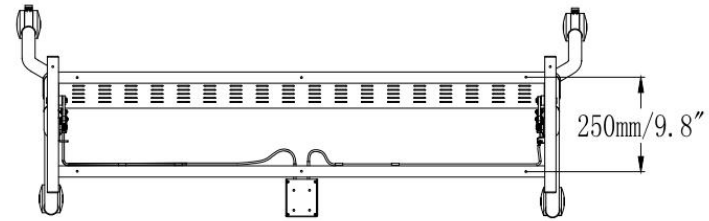

Round

# PALERMO LS-4-8A

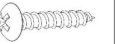

Dimension			
	Length	Depth	Height
Metal frame	1190/1490/1790mm	360mm (bracket) 500mm (base)	723mm
Table top	1200/1500/1800mm	500-600mm	25mm

**Easy assembly:** set up in just minutes with pre-assembled units

Assembly instruction			
1		Base	1pc
2		Base	1pc
3		Table Frame	1pc
4		M8*20	4pc
5		Table Top	1pc
6		ST4*45	6pc
7		ST4*14	4pc
8		ø8	4pc

I.

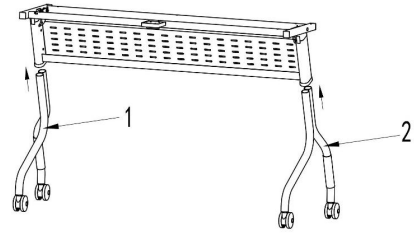

II.

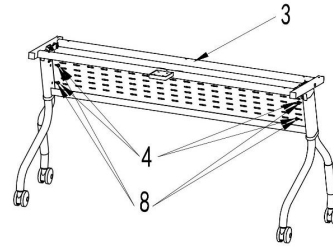

III.

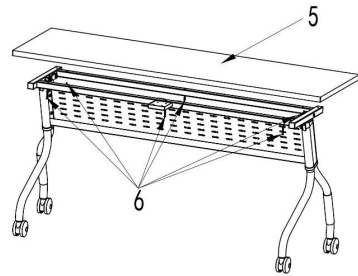

IV.

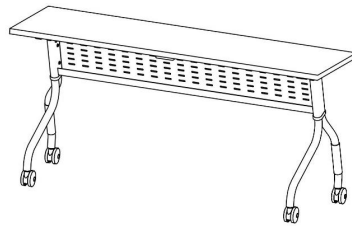
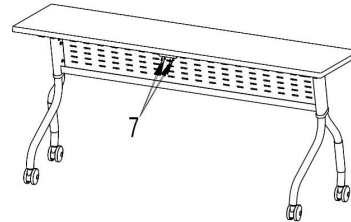

## You may also like...

### • Aluminum alloy base



Odeon LS-418



Verano LS-418D



Delvin LS-414



Boston LS-420

### • Steel base



Malco LS-4-6



Malco Plus LS-4-6A



Muller LS-4-3



Berlin LS-4-2